

◆ **Thermal protection**

When the inner temperature of flash light becomes too high the flash light will automatically decrease the brightness of the light.

◆ **Battery level indicator**

There are four colors to indicate the level of power left in the battery:
 When the indicator light is **BLUE**, the battery is fully charged.
 When the indicator light is **GREEN**, the battery is approx. imately 50% charged.
 When the indicator light is **RED** the battery charge is low. When the battery is very low / empty of indicator light will **FLASH RED** and then the light will power off.

◆ **Battery stretch**

When the battery level is low the flash light will automatically adjust the brightness (decrease) to conserve power. When the battery is empty then flash light will power off.

◆ **General maintenance**

There are two O-rings in the tail cap. Use silicone to keep the O-rings well lubricated. It is important to lubricate the O-rings if the flashlight has not been used in a long time or if the O-ring is hard. If the O-ring is damaged, broken or deformed it should be

NOTE: Do not use a sharp tool to rem

◆ **Warnings**

1. Only use 26650 Lithium batteries provided by the manufacturer.
 2. Do not open the tail cap when the flashlight is in the water.
 3. If the flash light will not be used for a long period of time the battery should be removed.
- Failure to comply with these warning may result in damage to the flashlight

◆ **Warranty**

Kraken provides a warranty against manufacturer defects for 1 year starting from the date of purchase. Manufacturer defects occurring within 15 days of the date of purchase will result in an exchange of product at the vendor. All other manufacturer defects occurring within 1 year of date of purchase will be repaired at no cost. Proof of purchase is required for warranty support. The warranty does not cover failures or defects resulting from misuse (e. g. modification, damage) natural disasters or battery

◆ **Trouble Shooting**

Before returning the flashlight to the vendor, please try the following to improve function.







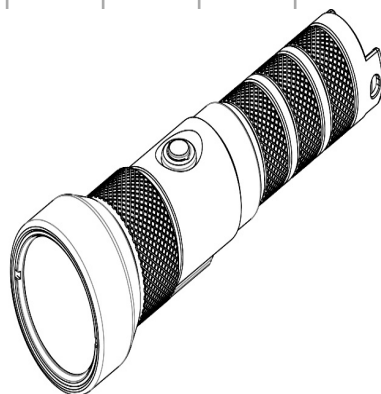

| | Solution |
|------------------------------|---|
| The flashlight does not work | * Check the battery to make sure that it is inserted in the correct direction * Check the battery is charged |
| Internal Leakage Wate | Check the O-Rings in the tail cap to make sure that they are not broken and that there is no debris which might prevent a proper seal |

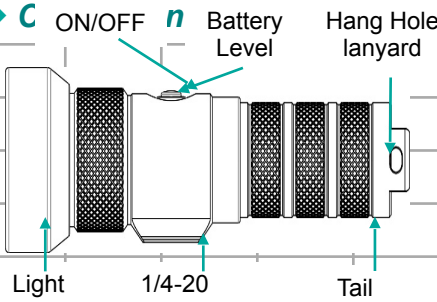
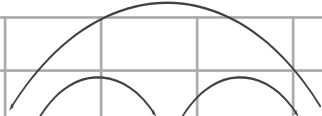

NR-2500
Diving Flash light



ad the manually carefully before using the F

| | | | | | |
|--|--|---|--|--|--|
| <p>◆ Overview</p> <p>The NR-2500 is a metal bodied diving flash light with LED (2500 lumens) .</p> | | <p>◆ Specifications</p> | | <p>Turn on SOS:</p> | |
| <p>◆ C ON/OFF n Battery Level Hang Hole lanyard</p>  | | <p>Type of Battery 26650 Li-ion battery (6000mAh) Lithium Battery with Type-C USB Charging Port</p> | | <p>When the light is off: Press the ON/OFF and hold it for two seconds. Switch mode: (Blink/SOS/Strobe)</p> | |
| | | <p>Brightness 2500 Lumens</p> | | <p>Switch mode: (Blink/SOS/Strobe)</p> <p>When the light is in SOS mode Press and immediately release the ON / OFF button</p> | |
| | | <p>Six function modes Continuous light modes: Full brightness (100%) / Medium brightness (50%) / Low brightness (25%). Intermittent light modes: Blink/SOS/Strobe</p> | |  | |
| | | <p>Color Temperature 6500K-7000K</p> | | <p>Blink SOS Strobe</p> | |
| <p>This flash light is very bright for its small size.</p> | | <p>Beam Angle Beam Angle 6 degrees</p> | | | |
| <p>Low risk of flashlight over heating (thermally protected)</p> | | <p>Burn time 85 minutes at full power</p> | | | |
| <p>Battery level indicator: Blue light (Battery full), Green light (Battery half), Red light (Battery low), Flashing red light (Battery very low) .</p> | | <p>LED Life Over 50,000 hours</p> | | <p>Turn off SOS:</p> | |
| <p>Battery stretch: When the battery is low, the flashlight will automatically adjust the brightness to 10% in order to conserve the remaining power.</p> | | <p>Depth Rating Depth Rating 100m / 330ft</p> | | <p>When the light is in SOS mode:</p> | |
| <p>Easy on-off: The flashlight is operated with a single push button located in the middle of the head.</p> | | <p>Size 54 mm (D) * 176 mm (L)</p> | | <p>Press the ON/OFF and hold it for two seconds.</p> | |
| <p>◆ I</p>  | | <p>Weight 400g on land & 190g underwater</p> | | <p>◆ To install the battery</p> | |
| | | <p>◆ To turn to flash light ON/</p> | | <p>1. Turn the tail cap counter -clockwise to open.</p> | |
| | | <p>Turn ON: Press the ON/OFF button and hold it for one second. The light will be 100% brightness.</p> | | <p>2. Put the 26650 Lithium battery in the tail cap.</p> | |
| | | <p>Turn OFF: Press the ON/OFF button and hold it down for two seconds.</p> | | <p>Note: Look at the label located on the inside of the tail cap,make sure to align the positive and negative ends of the battery with the positive and negative terminals on the tail.</p> | |
| <p>Flashlight</p>  | | <p>26650 battery with type-C USB charging port</p>  | | <p>3. Turn the tail cap clock wise to reattach the tail to the head of the flashlight.</p> | |
| <p>USB cable</p>  | | <p>O-Ring</p>  | | <p>◆ To charger the battery</p> | |
| <p>Black hand rope lanyard</p>  | | <p>To adjust brightness</p> | | <p>1. To charge the battery with the USB cable.</p> | |
| | | <p>When the light is on:</p> | | <p>2. The power can be able supplied by USB (5V, Maximum 2A)</p> | |
| | | <p>Press and immediately release the ON/OFF</p>  | | <p>3. When the battery begins to charge the indicator light on the battery will be RED.</p> | |
| | | <p>100% 50% 25%</p> | | <p>4. When the battery is fully charged the indicator on the battery will be BLUE.</p> | |

| | | | | |
|--|--|--|--|--|
| | | | | |
| | | | | |
| | | | | |
| | | | | |
| | | | | |
| | | | | |
| | | | | |
| | | | | |
| | | | | |
| | | | | |

| | | | | |
|--|--|--|--|--|
| | | | | |
| | | | | |
| | | | | |
| | | | | |
| | | | | |
| | | | | |
| | | | | |
| | | | | |
| | | | | |
| | | | | |